

INSTRUCTION MANUAL

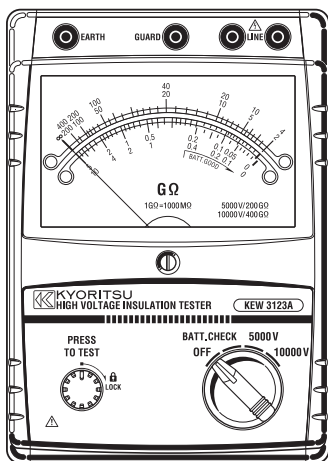

HIGH VOLTAGE INSULATION TESTER

KEW 3123A



**KYORITSU ELECTRICAL
INSTRUMENTS WORKS, LTD.**

CONTENTS

	Page
1. Safety warnings	1
2. Features	2
3. Specifications	3
4. Instrument Layout	4
5. Operating Instructions	5
5-1. Mechanical Zero Adjustment	5
5-2. Battery Check	5
5-3. Insulation Resistance Measurement	5
5-4. Continuous Measurement	6
5-5. Use of Guard Terminal	7
6. Battery Replacement	8
7. Accessories and options	8
7-1. Metal part for Line Probe, and replacement	8
7-2. How to use the adaptor for recorder	9
8. How to fix the Meter to the Hard case	10
9. Cleaning Meter Cover	11

1. Safety warnings

Please read through these operating instructions before starting to use the instrument to avoid any dangers such as electrical shock and to ensure safe operation of the instrument.

Pay particular attention to all WARNING and CAUTION in this instruction manual. WARNING indicates warnings to avoid electrical shock and CAUTION indicates cautions to avoid damage to the instrument.

WARNING

- This instrument cannot test live conductors. Ensure that the circuit to be tested is powered off before performing a test.
- Never open the Battery cover or remove the Instrument panel during a measurement.
- Confirm that the Rotary switch is at the OFF position and then connect the test leads.
- Do not attempt to make measurement in the presence of flammable gasses. Otherwise, the use of the instrument may cause sparking, which can lead to an explosion.
- Never attempt to make any measurement if any abnormal conditions, such as a broken cover or exposed metal parts are present on the Instrument or test leads.
- Do not use the instrument if the instrument is wet.
- Keep your fingers and hands behind the protective fingerguard during measurement.

CAUTION

- Do not expose the instrument to direct sunlight, high temperatures, humidity or dew.
- Power off the instrument after use. Remove the batteries if the instrument is to be stored and will not be in use for a long period.
- This instrument isn't dust & waterproofed. Keep away from dust and water.
- Use a damp cloth with neutral detergent or water for cleaning the instrument. Do not use abrasives or solvents.

2. Features

- Battery powered, the instruments test insulation up to 200G Ω at 5000V and 400G Ω at 10000V.
- Suited for heavy duty electrical maintenance and servicing of industrial installations, cables, transformers, generators and switchgear where high voltage insulation tests are required.
- Dual scales for low and high ranges which change automatically. Color coded scales for easy reading plus LEDs that illuminate in matching color.
- Drip proof construction. The case is sealed with rubber gaskets to protect internal circuit against rain.
- Hard carrying case furnished as standard accessory. Houses both instrument and test leads in compact form. Made of plastic, it is highly water resistant.
- Designed for low power consumption. Since the maximum current consumption is 90mA eight pieces of 1.5V SUM-3 (or equivalent) permit about 6 hours of continuous operation even when the instrument is used on maximum load or twice longer on minimum load.
- Rated output voltage is maintained down to 0.2G Ω /0.4G Ω . This permits accurate measurements of low insulation resistance.
- Optional adapter MODEL8324 is available for connection to recorder and enables cable insulation monitoring.

3. Specifications

		KEW 3123A	
DC Test Voltage		5000V	10000V
Measuring Ranges		0 to 5G Ω /2 to 200G Ω (automatic change)	0 to 10G Ω /4 to 400G Ω (automatic change)
Accuracy	Insulation Resistance	$\pm 5\%$ of reading (0.2 to 100G Ω) $\pm 10\%$ of reading or 0.5% of scale length (ranges other than listed above) at 23 $^{\circ}$ C $\pm 5^{\circ}$ C	$\pm 5\%$ of reading (0.4 to 200G Ω) $\pm 10\%$ of reading or 0.5% of scale length (ranges other than listed above) at 23 $^{\circ}$ C $\pm 5^{\circ}$ C
		$\pm 10\%$ of reading (0.2 to 100G Ω) $\pm 20\%$ of reading or 1.0% of scale length (ranges other than listed above) at -10° C to $+40^{\circ}$ C	$\pm 10\%$ of reading (0.4 to 200G Ω) $\pm 20\%$ of reading or 1.0% of scale length (ranges other than listed above) at -10° C to $+40^{\circ}$ C
	Output Voltage	5000V $\pm 5\%$ (0.2 to 100G Ω)	10000V $\pm 5\%$ (0.4 to 200G Ω)
Operating Temperature & Humidity		-10° C to $+40^{\circ}$ C at 85% max. relative humidity	
Storage Temperature & Humidity		-20° C to $+60^{\circ}$ C at 90% max. relative humidity	
Insulation Resistance		1000M Ω max./ 1000V between electrical circuit & housing case	
Withstand Voltage		5000V AC for one minute between electrical circuit & housing case	
Dimension		200(L) \times 140(W) \times 80(D) mm	
Weight		Approx. 1kg (including batteries)	
Power Source		8 pcs of R6P (AA) battery or equivalent	
Accessories		Hard Carrying Case:M-9158 Batteries, Test Leads (Line Probe:M-7165A, Earth Cord:M-7224A, Guard Cord:M-7225A) Pickel type prod:M-8019	
Optional accessories		Line cord with alligator clip : M-7168A Optional adapter : M-8324	

4. Instrument Layout

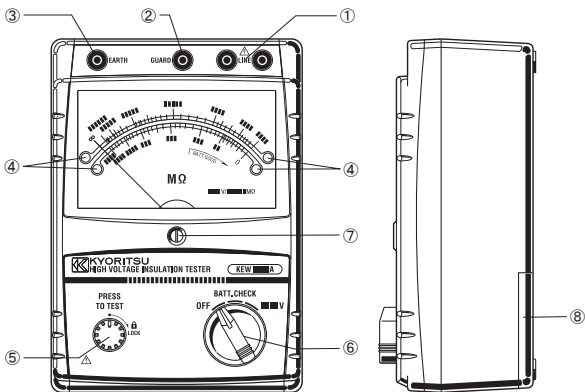
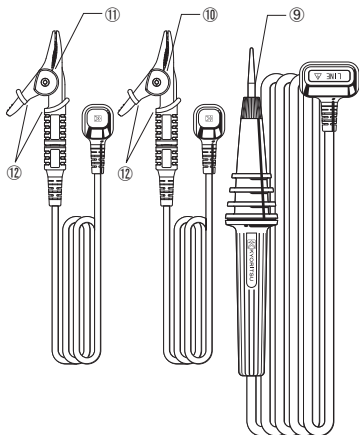

Fig.1

- ① Line Terminal
- ② Guard Terminal
- ③ Earth Terminal
- ④ LEDs for High & Low Range Indication
- ⑤ Press to Test Button
- ⑥ Function Switch
- ⑦ Meter Movement Zero Adjust
- ⑧ Battery Compartment Cover
- ⑨ Line Probe (Red)
- ⑩ Earth Cord (Black)
- ⑪ Guard Cord (Green)
- ⑫ Protective fingerguard:



It is a part providing protection against electrical shock and ensuring the minimum required clearance and creepage distance.

5. Operating Instructions

WARNING

BE CAREFUL ABOUT HIGH VOLTAGE PRESENT ACROSS LINE AND EARTH TERMINALS OF INSTRUMENT WHEN PRESS TO TEST BUTTON IS OPERATED. MAKE SURE TO EARTH CIRCUIT UNDER TEST. ALWAYS CONNECT EARTH TERMINAL OF INSTRUMENT TO EARTH. THE BUZZER WILL KEEP SOUNDING DURING INSULATION RESISTANCE MEASUREMENT.

5-1. Mechanical Zero Adjustment

With the function switch set at OFF position, adjust the meter pointer to “∞” mark on the scale. Use a screwdriver to turn the zero adjust screw located at the center of the front panel.

5-2. Battery Check

With the function switch set at BATT. CHECK position, press the press to test button. The batteries are good when the pointer stays in BATT. GOOD area or to the right of this area. If not, replace them.

CAUTION

Refrain from holding down or locking the press to test button during this test as it will result in current consumption larger than insulation resistance measurement while the batteries are still new.

5-3. Insulation Resistance Measurement

With the function switch set at OFF position, always connect the circuit under test to earth. Attach the test lead to the earth terminal of the instrument and connect to the earthed side of the circuit under test. With the function switch set at 5000V or 10000V,

connect the black earth code to the earth terminal (EARTH) and place the line probe in contact with the circuit under test and press the Test button. When the green LED illuminates, read insulation resistance on the outer scale (for high range). Use the inner scale where the red LED illuminates. For insulation testing at 5000V and 10000V, read the black and red scales respectively.

 **WARNING**

After a test, release the press to test button and wait for several seconds without disconnecting the line probe from the circuit tested. This is intended to discharge the charge stored in the circuit tested.

5-4. Continuous Measurement

Make sure that the circuit under test is earthed and that the test lead attached to the earth terminal of the instrument is connected to the earthed side of the circuit under test. Push the press to test button and turn clockwise to lock for continuous measurement. When making this measurement, good care must be taken against the high voltage continuously present across the line and earth terminals of the instrument.

Note: Make certain that the circuit under test does not include components which will be damaged by the high voltage applied.

 **WARNING**

Pay extra caution at operating the instrument since high voltage will be continuously generated during a measurement. Keep your fingers behind the protective fingerguard during a measurement.

5-5. Use of Guard Terminal

When measuring the insulation resistance of a cable, leakage current flowing on the surface of cable jacket and the current flowing inside the insulator are mixed and may cause error in insulation resistance value. In order to prevent such error, wind a conductive wire around the point where leakage current flows. Then connect it to the Guard terminal as shown in below Fig. 2. This is to move out the surface leakage resistance of the cable insulation to measure only the volume resistance of insulator. Make sure to use the Guard cord supplied with this instrument to connect the instrument to Guard terminal.

Connect the terminals with reference to the following figure of an equivalent circuit.

* Wind a protective wire, any conductive bare wires are ok, around the point where leakage currents flow. Then connect it to the Guard terminal as follows.

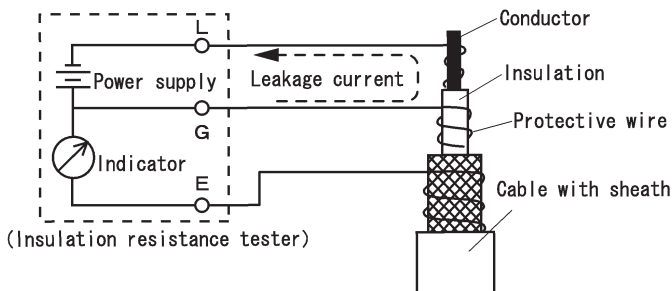

Fig.2

* It is possible to move out the surface leakage resistance of the insulation and measure only the volume resistance by using the Guard terminal. This is helpful when performing tests in humid air.

6. Battery Replacement

Remove the battery compartment cover by loosening the screw located on the back of the housing case. Replace the whole battery pack. Alkaline batteries are recommended where the instrument is used at a temperature below the freezing point. The ordinary manganese batteries will deteriorate below the freezing point.

7. Accessories and options

7-1. Metal part for Line Probe, and replacement

(1) Tip metal parts

MODEL8252: Standard Prod (straight type, with molded parts)

MODEL8254: Straight Type Prod

MODEL8019: Pickel Type Prod (accessory)

To be used to hook the instrument.

(2) How to replace it

Turn the Line probe counterclockwise to remove the attached tip metal. Put the tip metal you want to use to the hexagon socket and turn it to clockwise together with the tip of probe, and tight up screws.

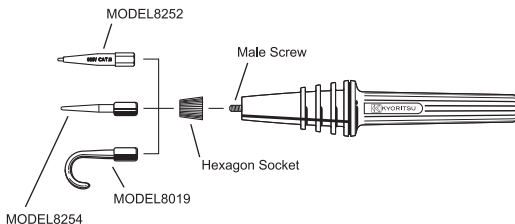

7-2. How to use the adaptor for recorder

MODEL8324 is the adaptor for recorder for output current measurement. Connect it as shown in the below Fig.3.

Output is DC10mV when current of $1 \mu\text{A}$ is flowing.

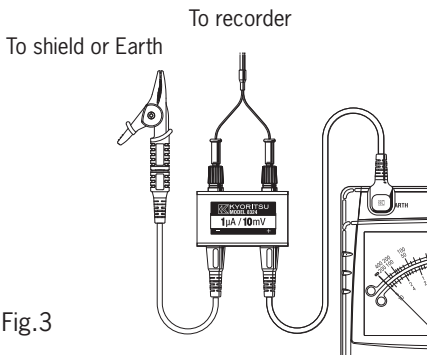

8. How to fix the Meter to the Hard case

1. Place a hard board beneath the Hard case.
The board should be located under the Dual Lock™ Reclosable Fastener attached to the Hard case.

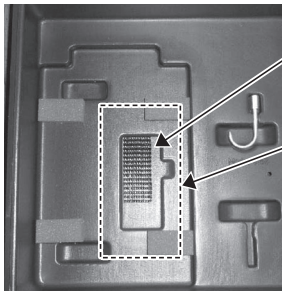

Dual Lock™ Reclosable Fastener

A hard board should be placed in the location as indicated by dotted lines.

2. Put the unit in place, and then press down the sides of the unit so that the mushroom-shaped stems on the fastener are engaged each other with audible snap sound.

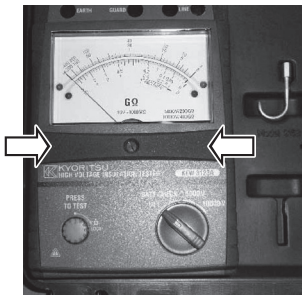

Pressing down the sides of unit (as indicated by arrow marks) engages the stems on the fastener.

9. Cleaning Meter Cover

This earth tester is managed by our company's quality standard and is delivered in the best condition after passed the inspection. But in the dry time of winter static electricity sometimes builds up on the meter cover due to the characteristic of plastic.

⚠ CAUTION

When the pointer deflects by touching the surface of this tester or zero adjustment can not be made, do not try to make measurement.

When static electricity builds up on the meter cover and affects the meter reading, use a cloth dampened with off-the-shelf anti-statics agent or detergent to wipe the meter cover surface.

Never use detergent including organic solvent so as not to deform or discolor the meter cover.

DISTRIBUTOR

Kyoritsu reserves the rights to change specifications or designs described in this manual without notice and without obligations.



**KYORITSU ELECTRICAL
INSTRUMENTS
WORKS, LTD.**

No.5-20,Nakane 2-chome, Meguro-ku,
Tokyo, 152-0031 Japan

Phone: +81-3-3723-0131

Fax: +81-3-3723-0152

Factory: Ehime

www.kew-ltd.co.jp